



Inspection of Fastener Hole Cracks Using Motorized Remote Field Eddy Current Probe

Yushi Sun, Weiqiang Wan, Changhong Sun, Xinle Yang, Haiou Zhu Tianhe Ouyang

Innovative Materials Testing Technologies, Inc.

3141 W. Torreys Peak Drive, Superior, CO 80027

Tel: 303 554 8000

Fax: 303 554 8001

Email: suny@imtt-USA.com

Challenges in Thick & Multilayer Structure Crack Detection

1. Requirement of deep penetration in multilayer structure
2. Structure variations around a fastener – background noise comparable or greater than crack signal
3. Material property variations, such as permeability variation of a steel fastener.
4. Extremely weak crack signal submerged in background noise and structure variation signals
5. Signal magnitude is not necessarily be the indication of existence of a crack. Other parameters, signal phase angle or signal shape must be used for crack identification
6. Signal processing or/and pattern recognition is needed for crack identification and quantification

Our Choices

- 1. Use Remote field Eddy Current Technique (RFEC) to get deep penetration and high sensitivity**
- 2. Use rotational probe to minimize noise from fastener**
- 3. Use motorized rotational probe/scanner to get constant rotation speed which enables on-the-spot signal processing**
- 4. Utilize the shape features of impedance plane for crack identification**
- 5. Use computerized instrument, SSEC, to automate the whole signal process and crack identification procedure**
- 6. Instant display, right after inspection, of crack identification & quantification results**

Rotational Scan – Minimizing noise from fastener

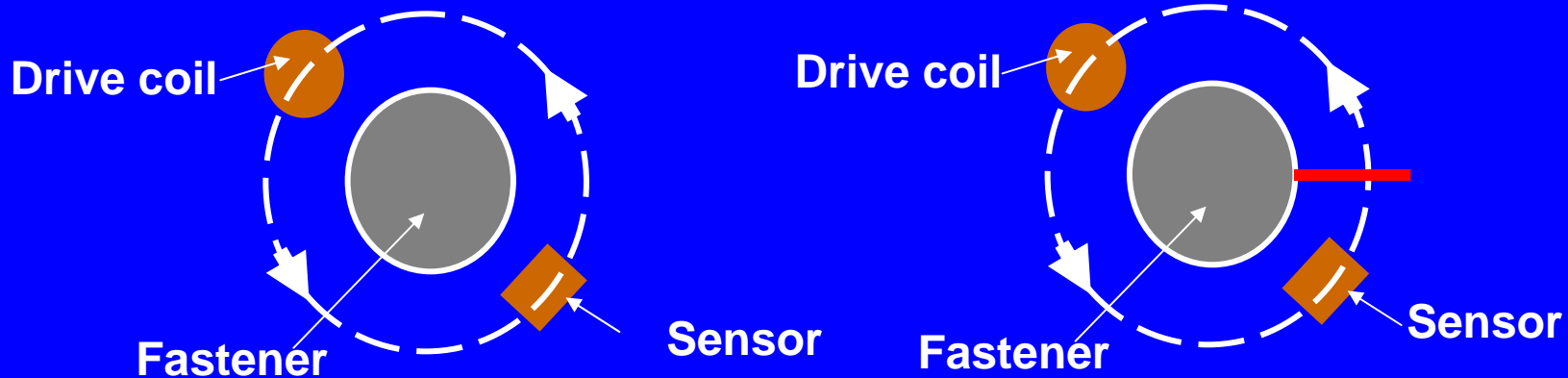

Probe Mode 1 – Constant signal unless there is a crack

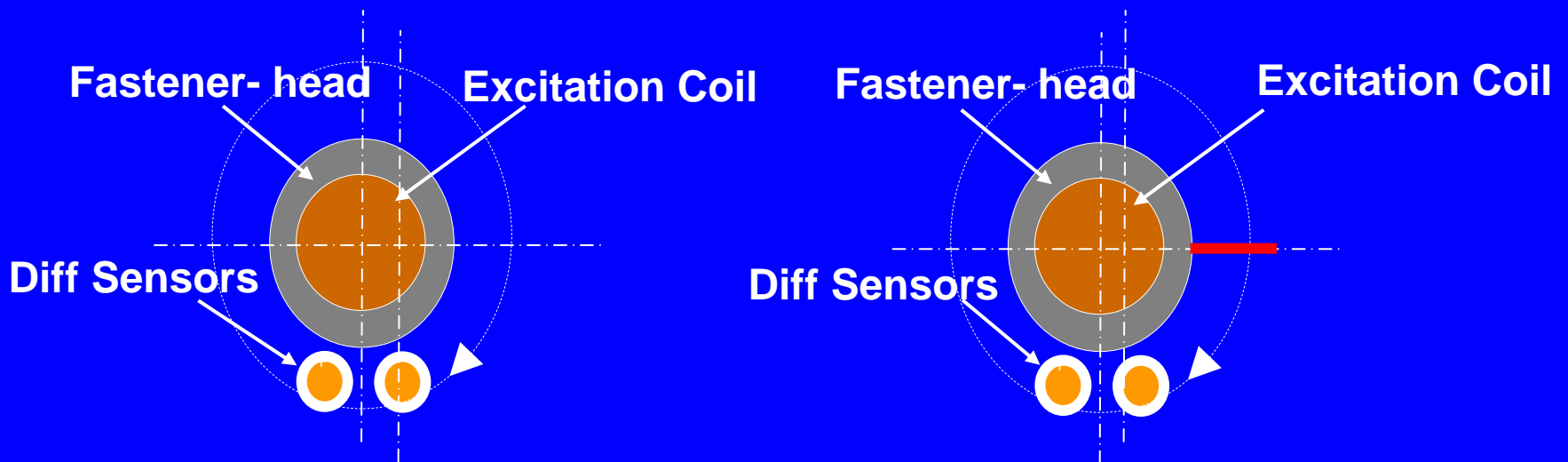

Probe Mode 2 – No signal unless there is a crack

Motor-Controlled Rotation Ensuring Repeatable Signal for Online Signal Processing & Hands-Free Operation

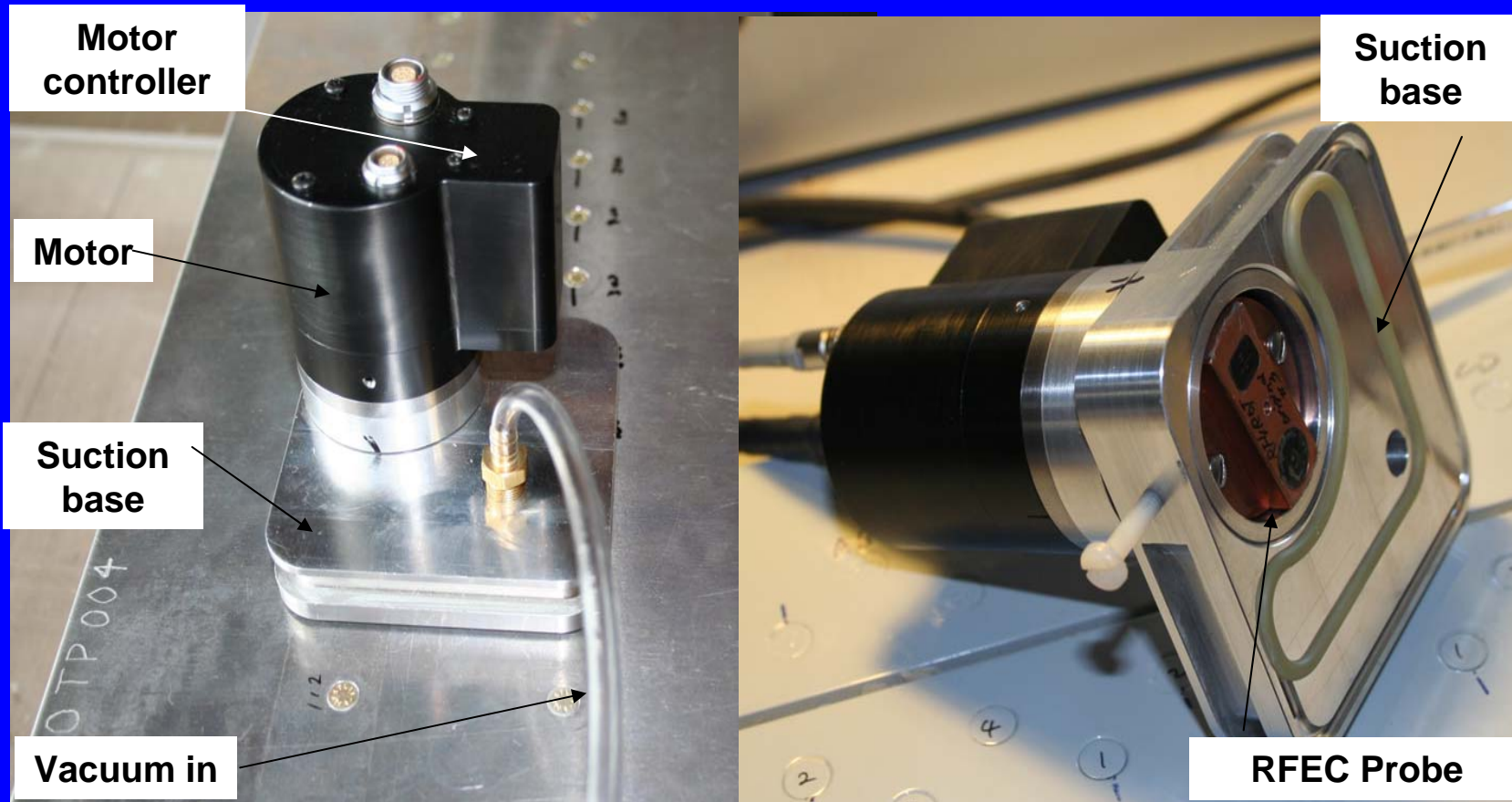

Computerized SSEC Instrument Enabling Online Signal Processing

Motorized
RFEC Probe

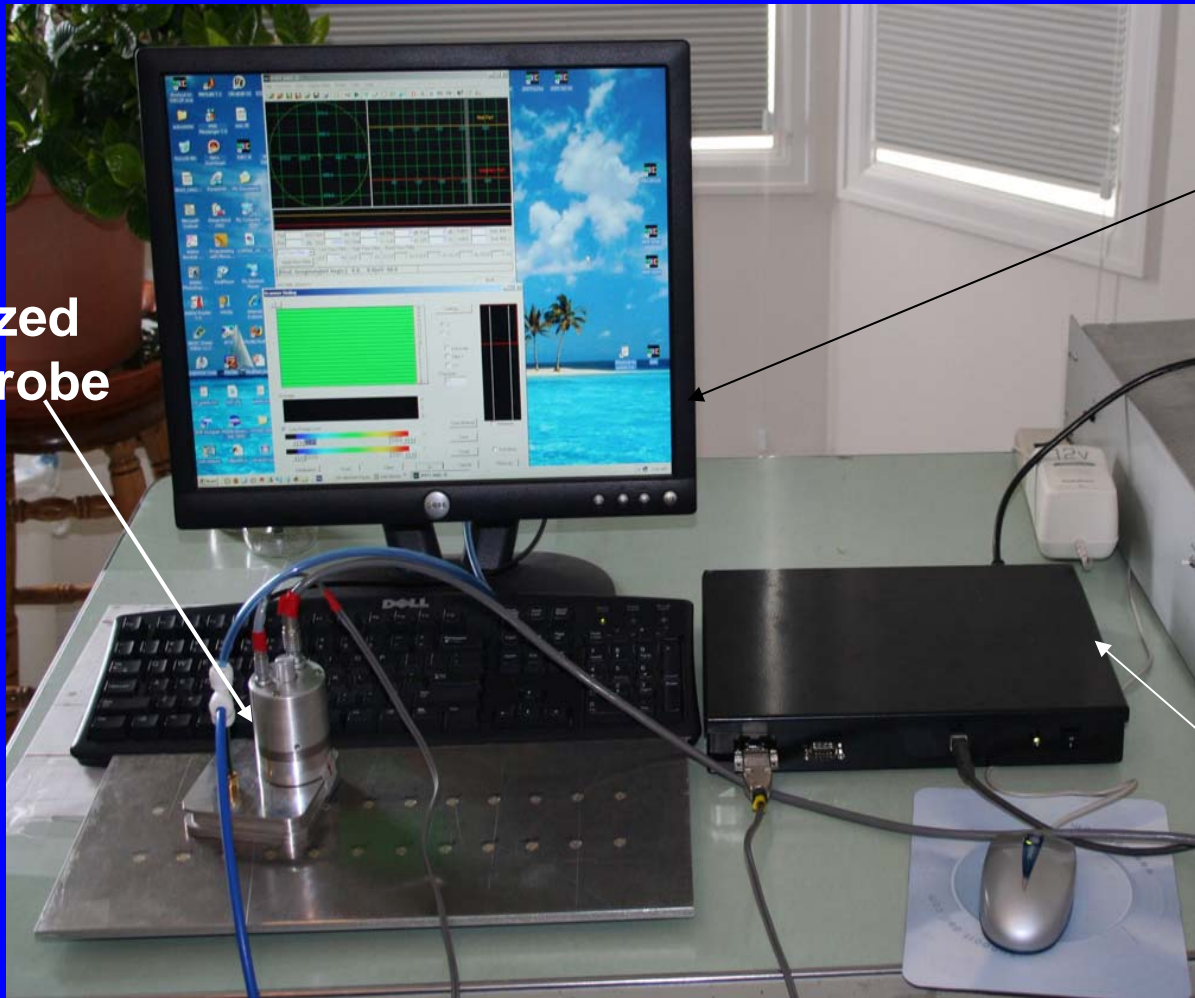





PC Monitor
or Laptop

Instrument
SSEC

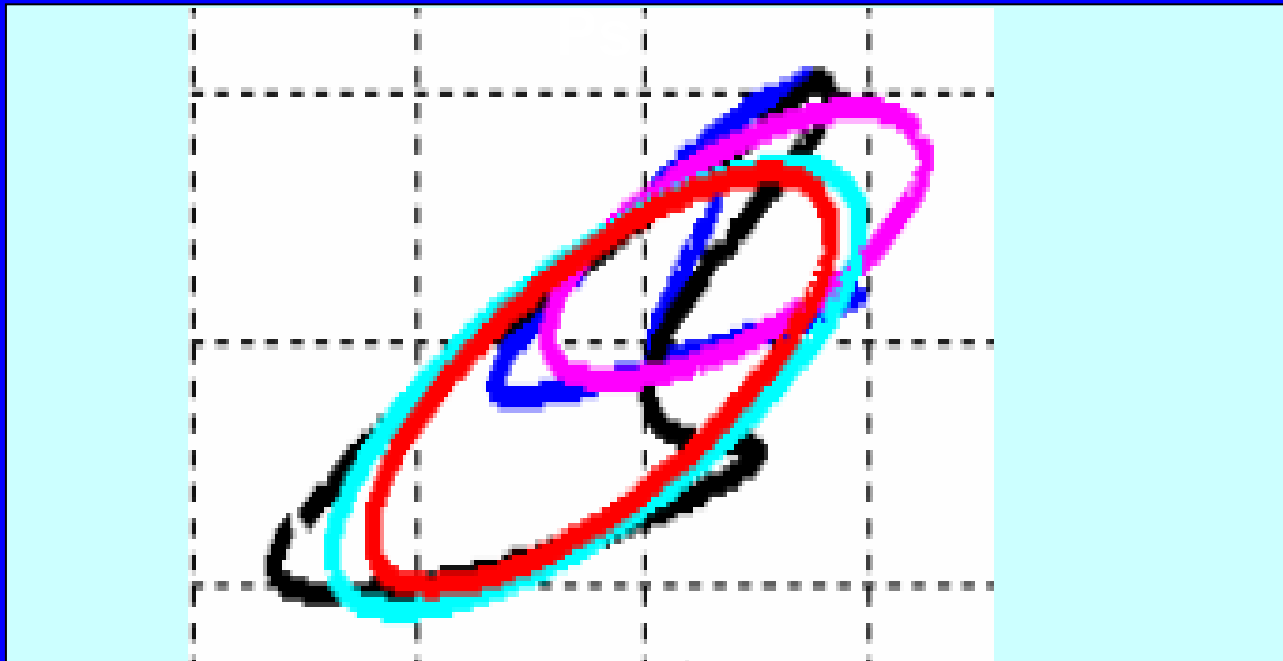
Examples of Crack Identification Algorithm

Ellipse curve fitting used to generate Factor of Symmetry

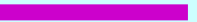
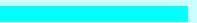

-  First portion of impedance plane
-  Second portion of impedance plane
-  Ellipse fit with the second portion of impedance plane
-  Ellipse fit with the first portion of impedance plane
-  Ellipse fit with the entire impedance plane

3 Levels of Crack ID

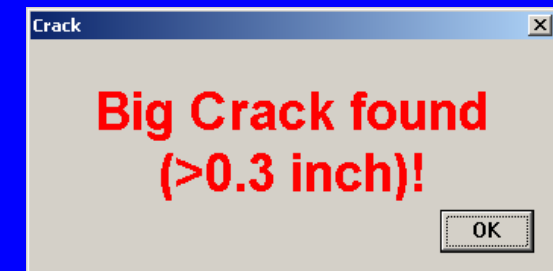
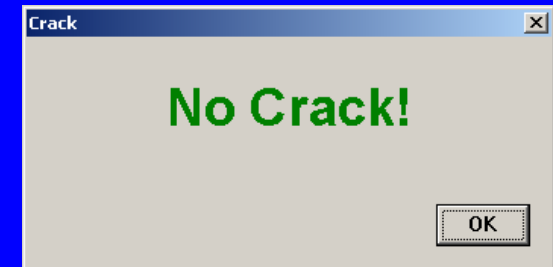

Application #1

C-130 Center Wing Inspection

- 3 skin panels thickness from 0.150" to 0.175" fastened to hat sections about 0.140" thick
- Test Piece: skin 0.250" thick, stringer 0.140" thick, Al 7075-T7351, ferrous fasteners

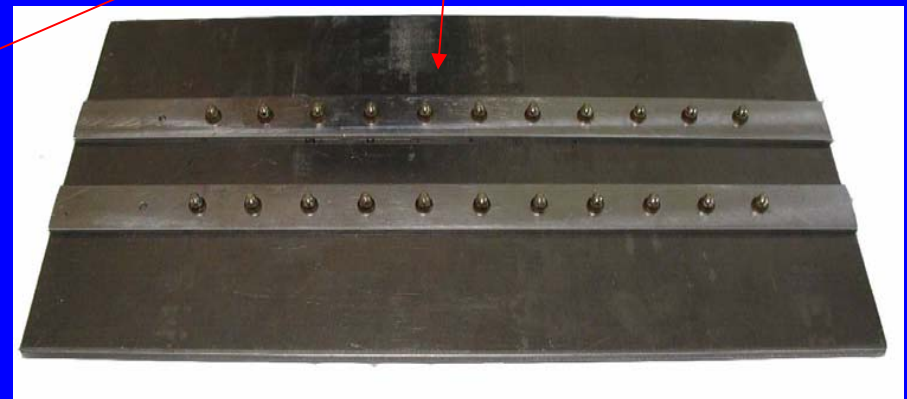
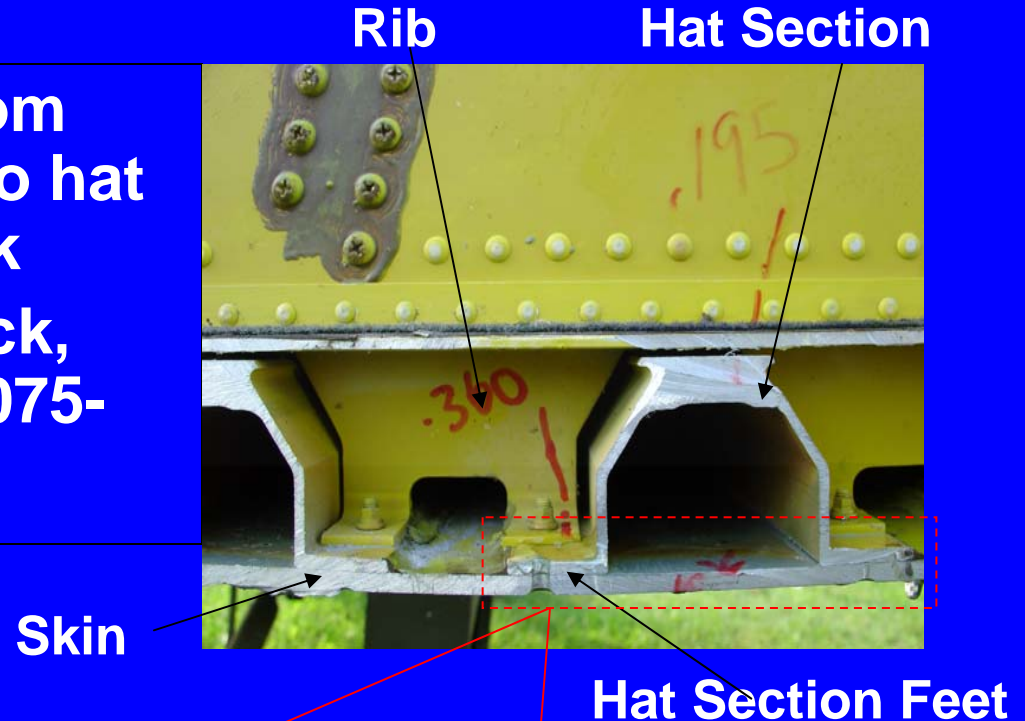



Application #1

Detection 2nd layer horizontally oriented cracks C-130 standard with nearby 2nd layer edge & steel fasteners

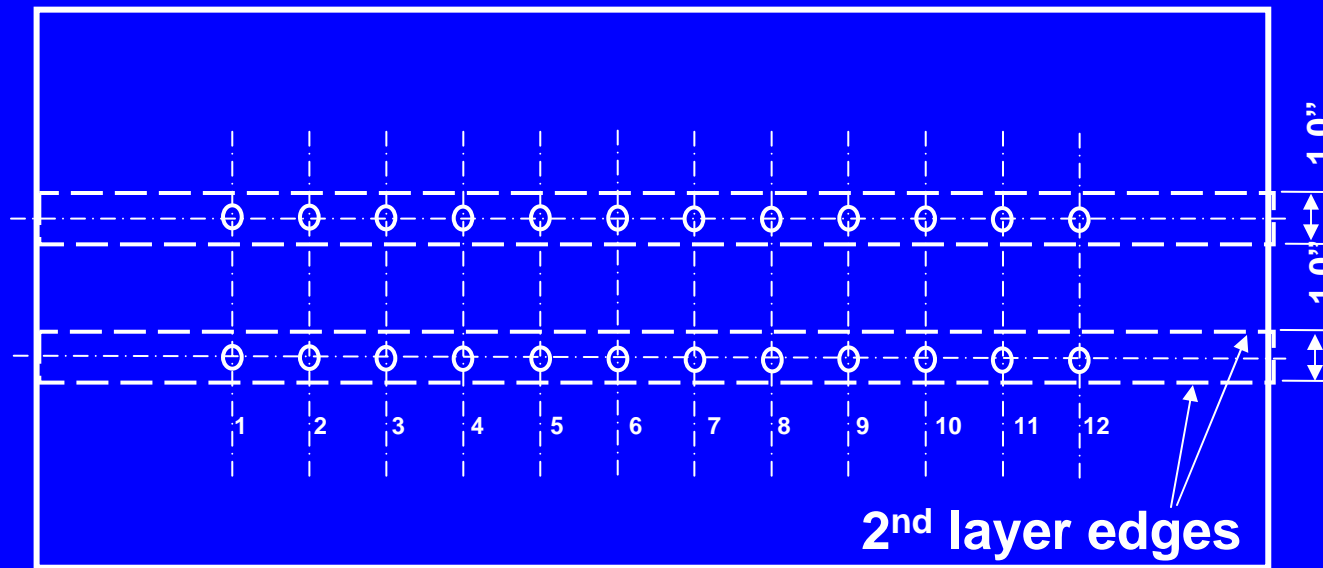

1st layer –
0.250"
Aluminum

2nd layer –
0.140"
Aluminum
Width =
1.000"

2nd Layer - Rectangular Notch

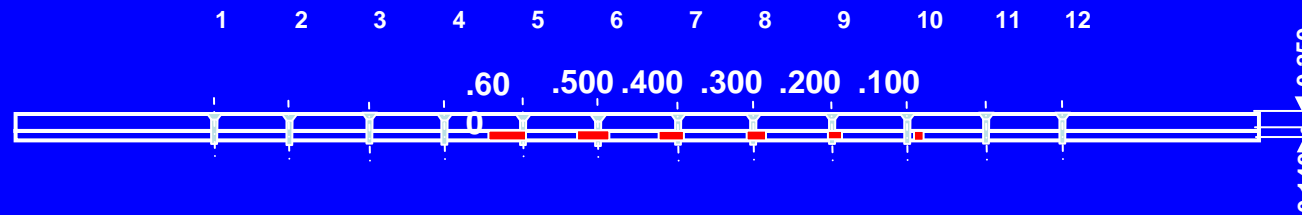

2nd layer EDM
notches –
0.100" -
0.600"



Application #1

Detection 2nd layer horizontally oriented cracks C-130 standard with closed 2nd layer edge & steel fasteners

No EDM Notch



Increase of EDM Notch Size



Watch Live Demonstration of the Test at
Exhibition Booth #26



Application #1

Detection 2nd layer horizontally oriented cracks C-130 standard with nearby 2nd edge & steel fasteners

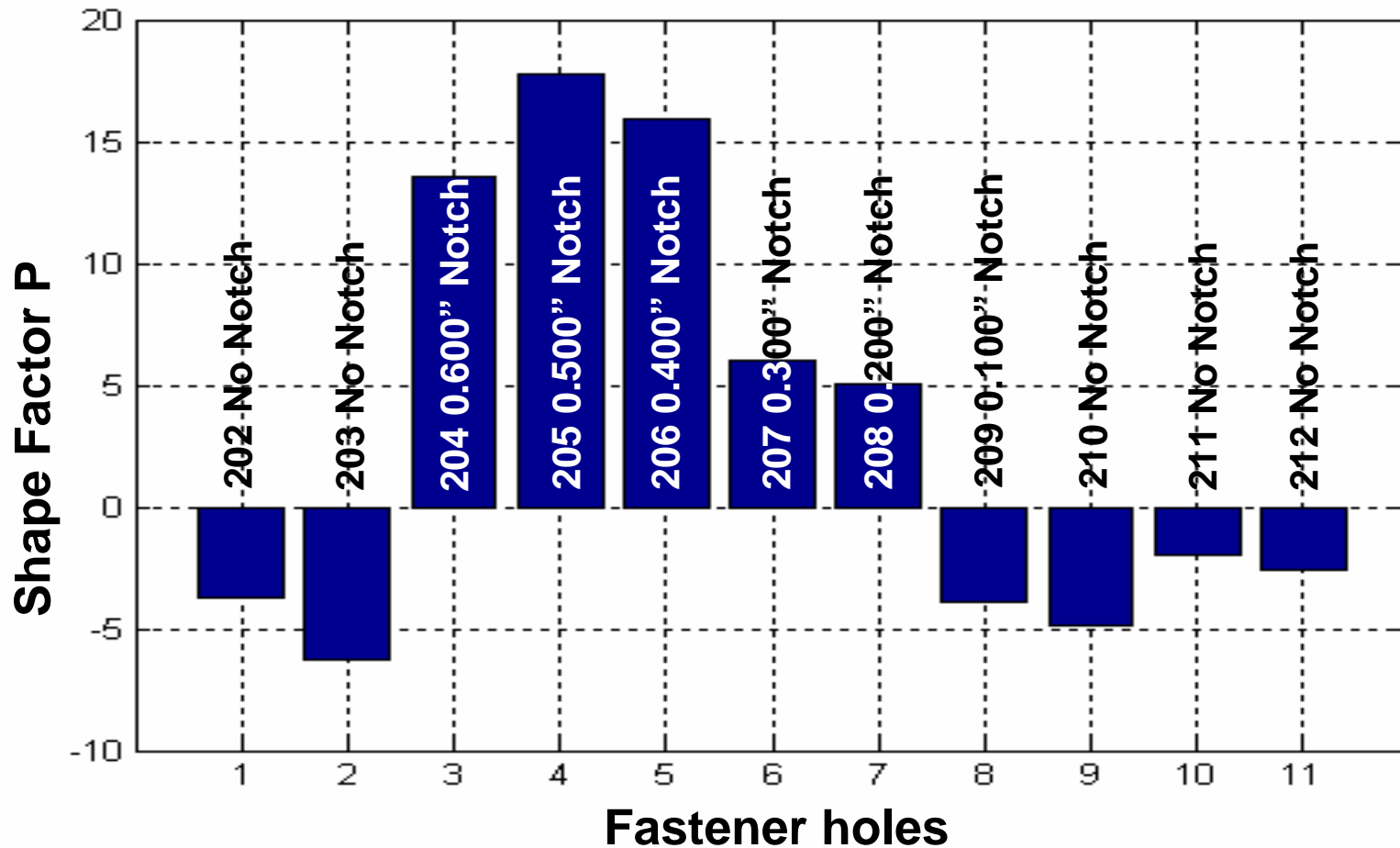

Watch Live Demonstration of the Test at
Exhibition Booth #26

Application #2

Boeing 707 Wing Structure Inspection

Detection 2nd layer vertical cracks
with Ti fasteners, crack nearby to 2nd layer edge

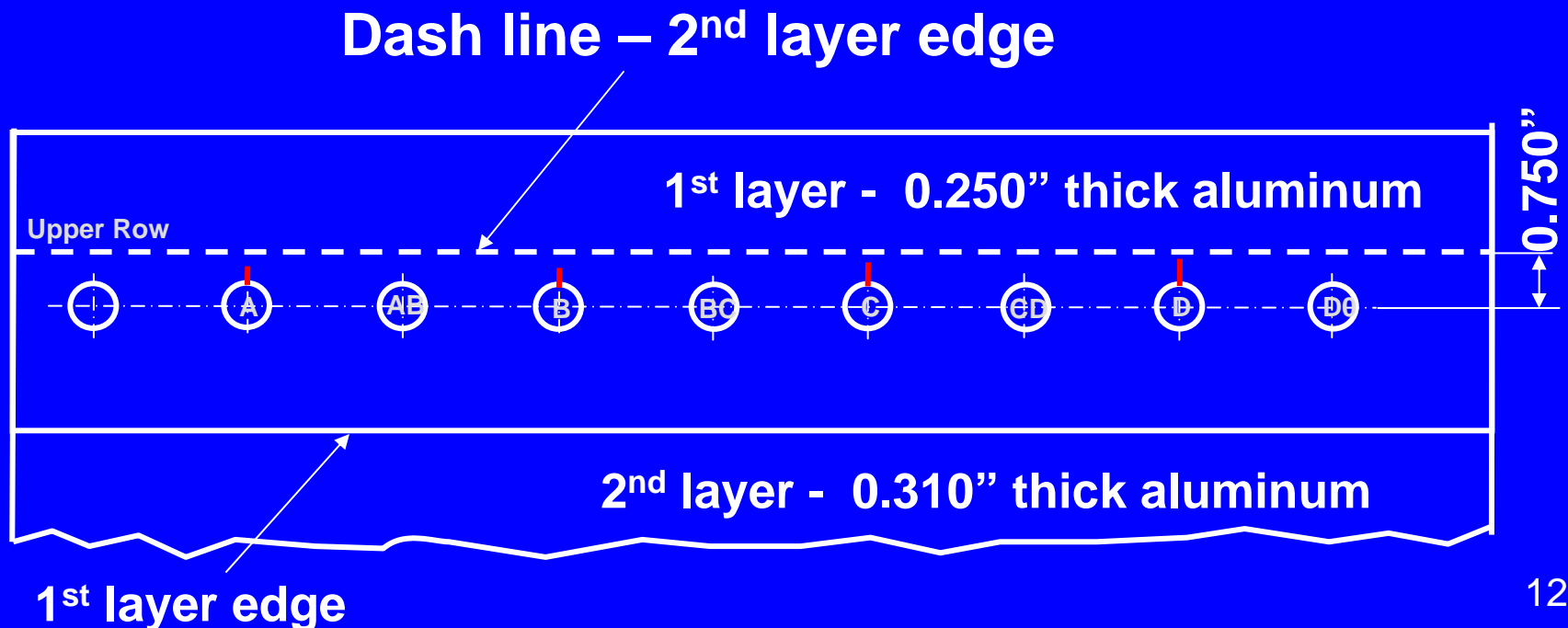

Application #2 Boeing 707 Wing Structure Inspection Impedance plane & ellipse fitting

2nd Layer Crack near 2nd Layer Edge **Non-Ferromagnetic** Fastener

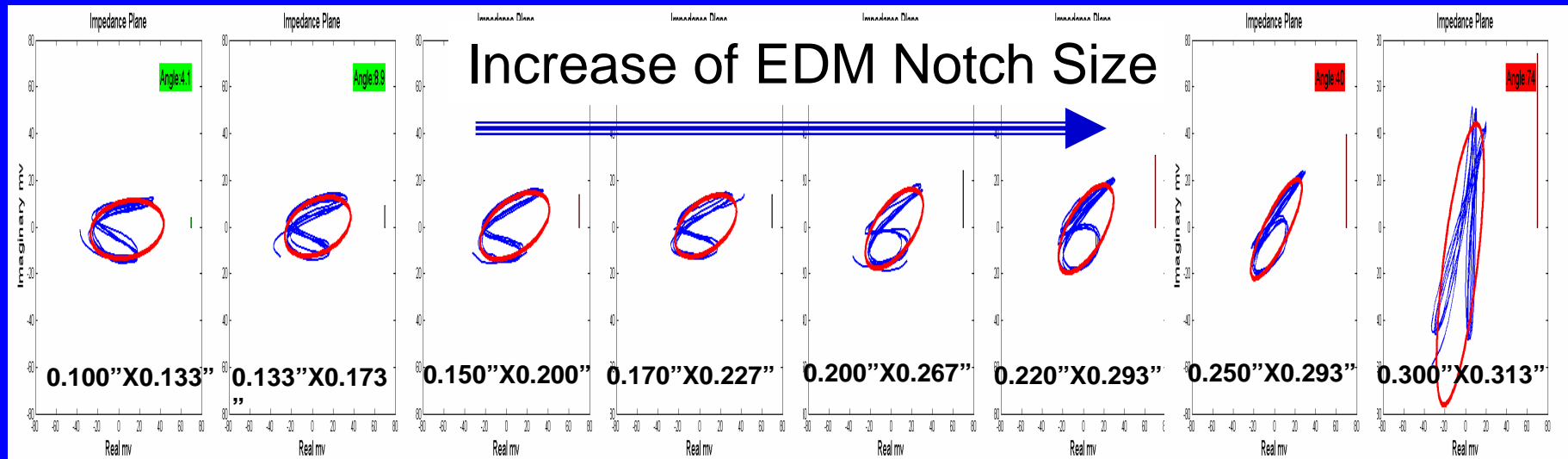
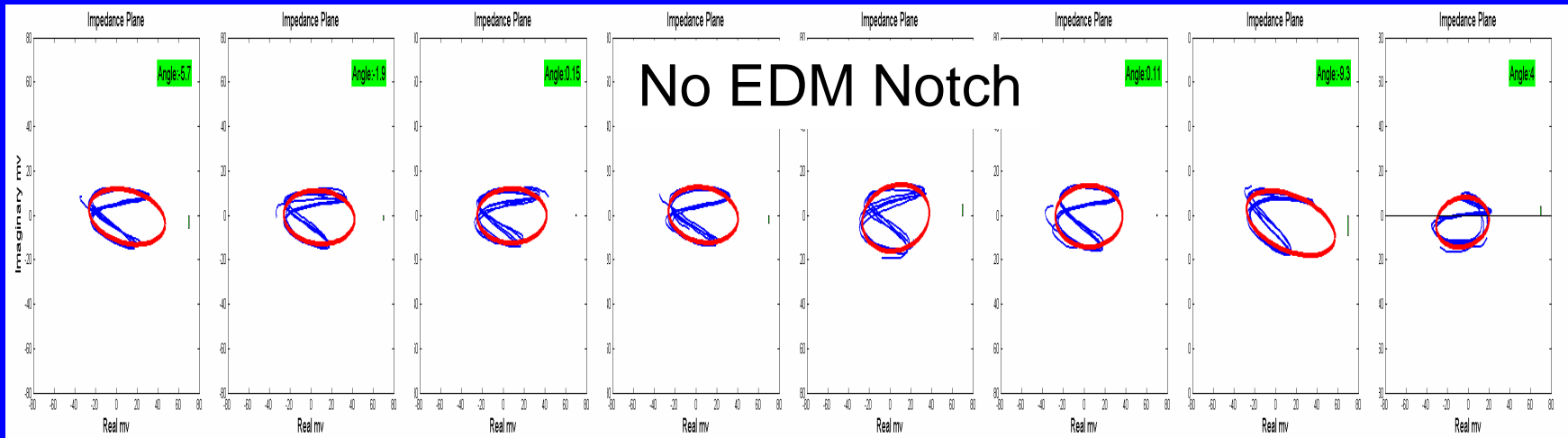

Application #2 Boeing 707 Wing Structure Inspection Impedance plane & ellipse fitting

2nd Layer Crack near 2nd Layer Edge **Non-Ferromagnetic** Fastener

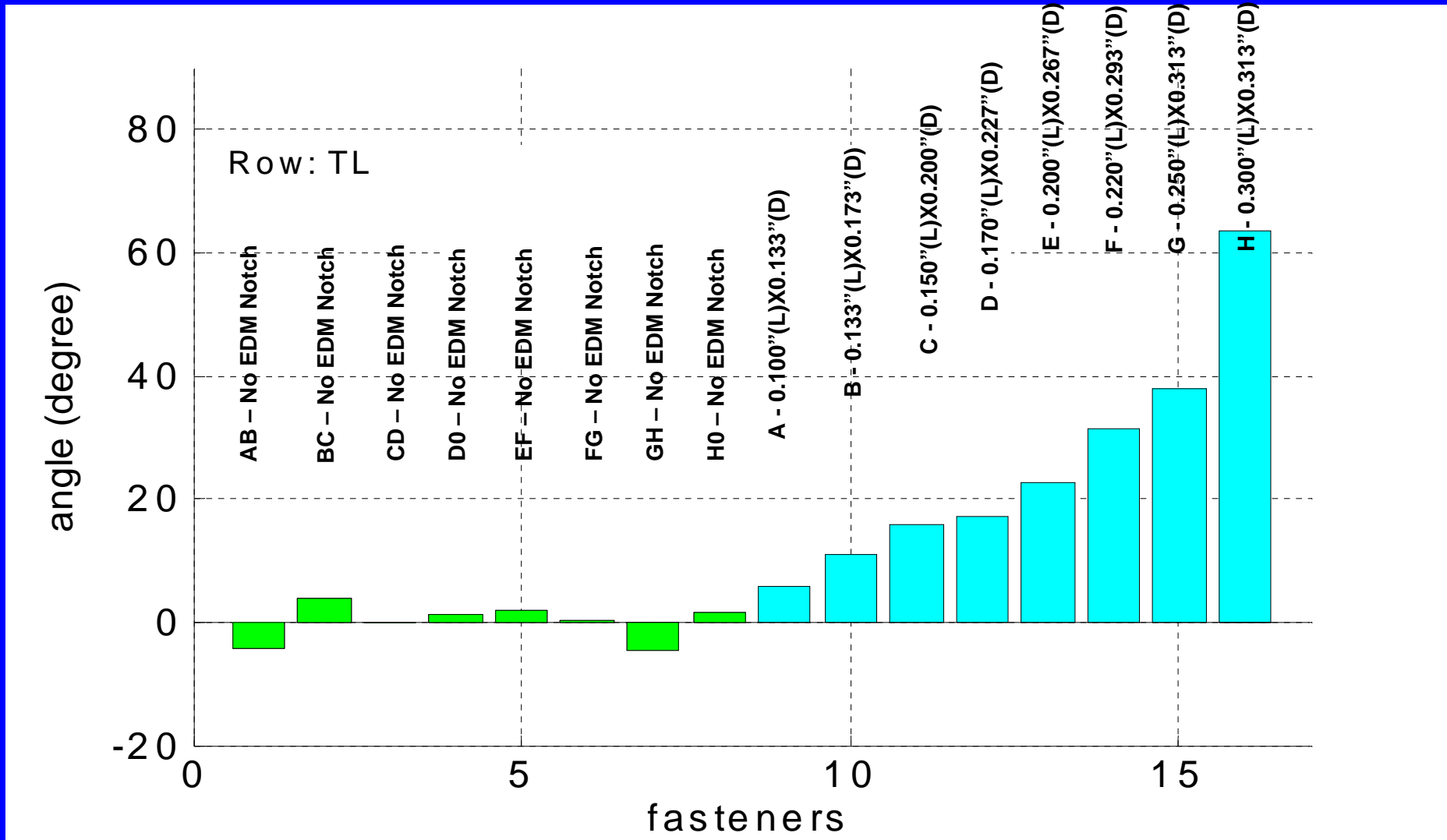

Observation: reliably detected EDM notch size ≥ 0.133 "

Application #2 Boeing 707 Wing Structure Inspection Impedance plane & ellipse fitting

2nd Layer Crack near 2nd Layer Edge Ferromagnetic Fastener

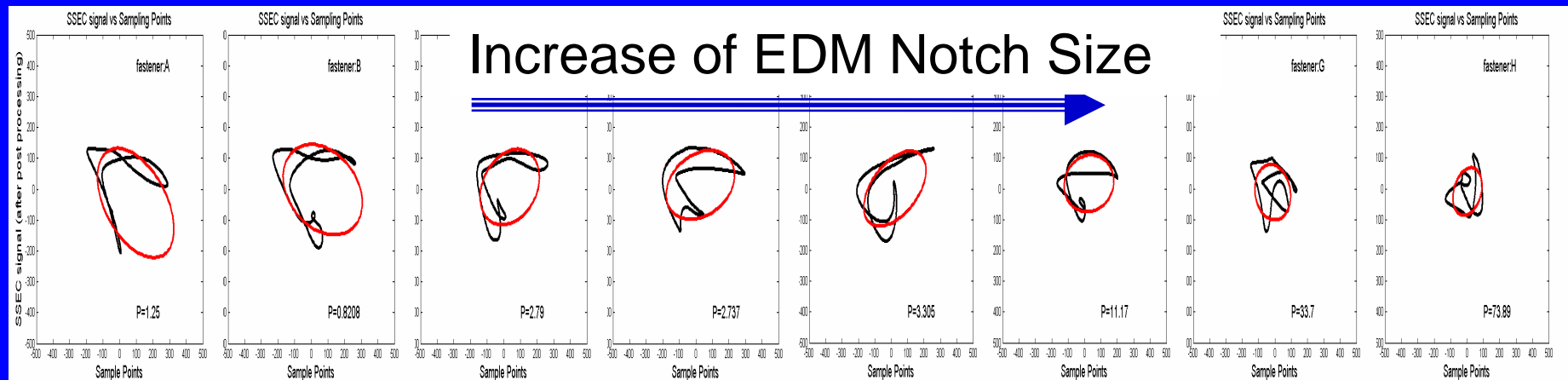
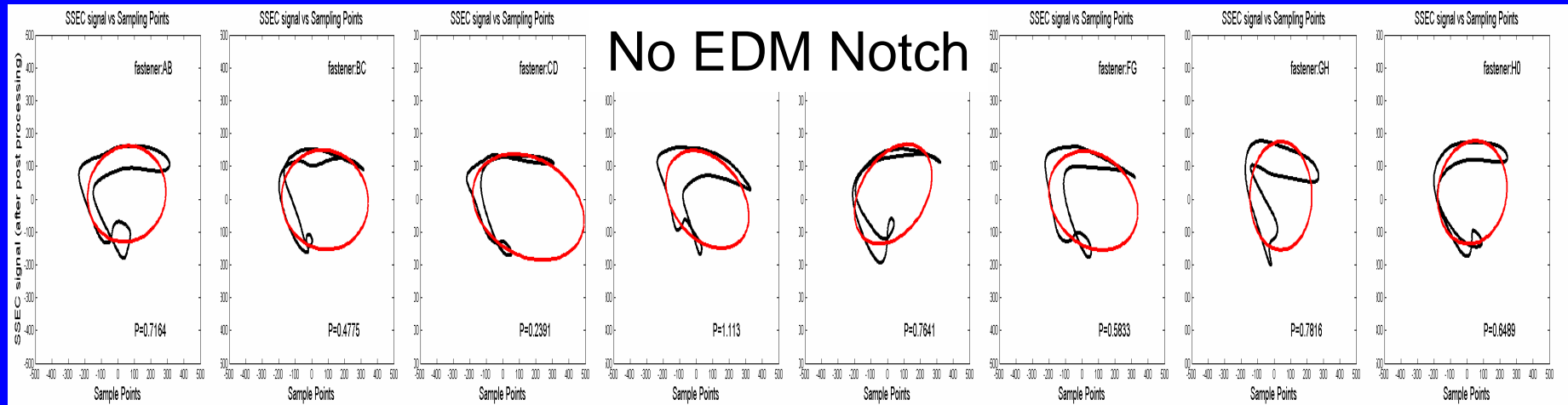

Signal decreases with increase of notch size and varies in its size and shape

Application #2 Boeing 707 Wing Structure Inspection Impedance plane & ellipse fitting

2nd Layer Crack near 2nd Layer Edge **Ferromagnetic** Fastener

Shape Factor P is used for Identifying a Notch

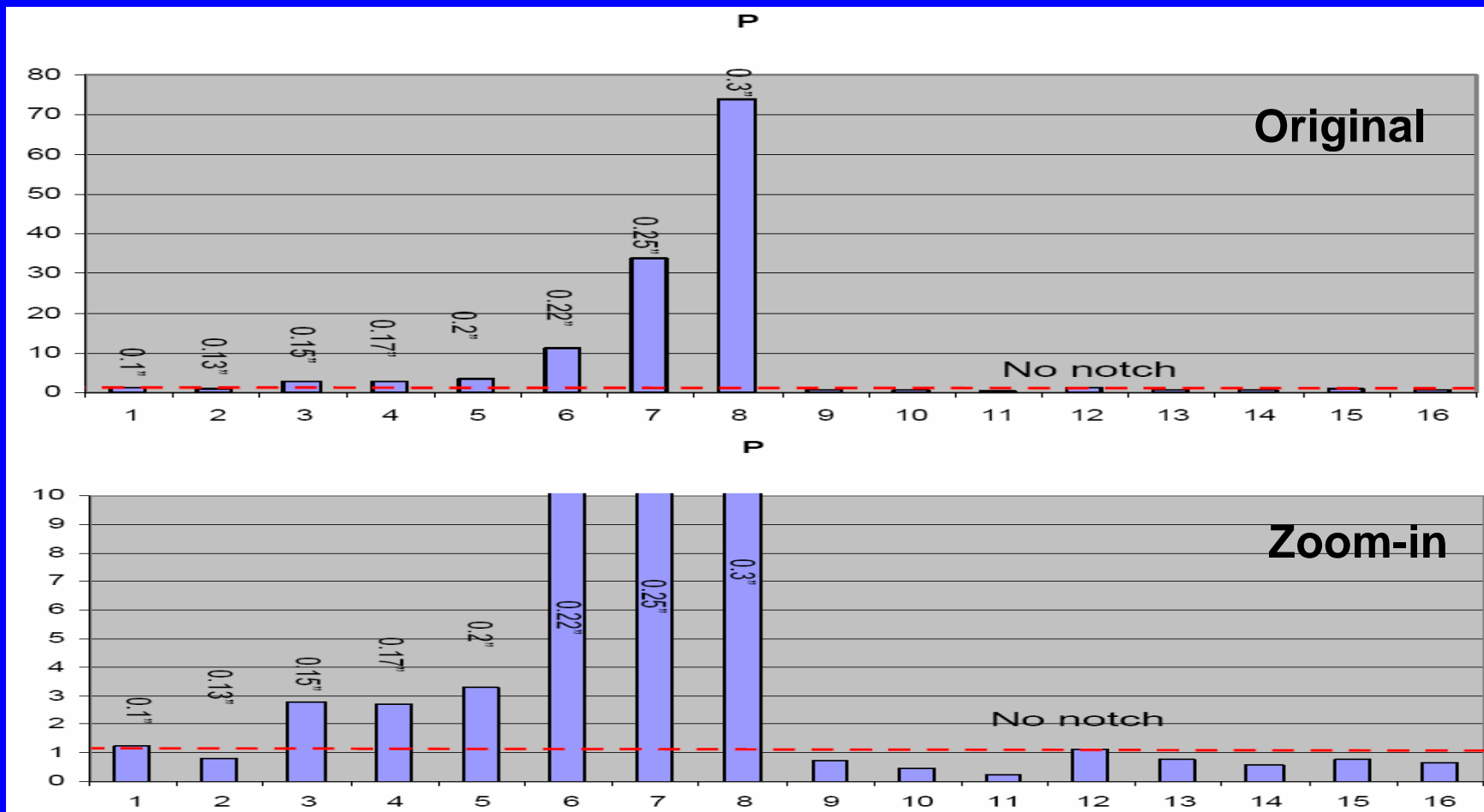

Observation: reliably detected EDM notch size ≥ 0.150 "

Summary

- 1. Signal magnitude is not necessarily be the indication of a deeply hidden crack. Signal phase and/or signal impedance shape can be used for crack identification.**
- 2. Motorized rotational RFEC probe/scanner provide the necessary features for detection of deeply hidden crack.**
- 3. Computerized instrument enables on-the-spot signal processing and crack identification.**
- 4. The motorized rotational probe/scanner also eases the inspection process and minimizes human factor in the inspection.**